



Fan designation: DN63V-4YK.D7.24.G9
Article number: 174058

Fan characteristics:

Design:	K (short casing)
Diameter:	630 mm
Temp. range:	-20/60 °C
ATEX range:	Ex II 2G c IIB+H2 T4
Casing finish:	G - hot dip galv. steel
Mouting position:	H/V (horizontal and vertical)
Location:	inside

Impeller data:

Airflow direction:	V (impeller -> motor)
Nb of blades:	9
Blade setting:	24°
Blade Material:	ZAmid ATEX
Impeller bolting:	A2

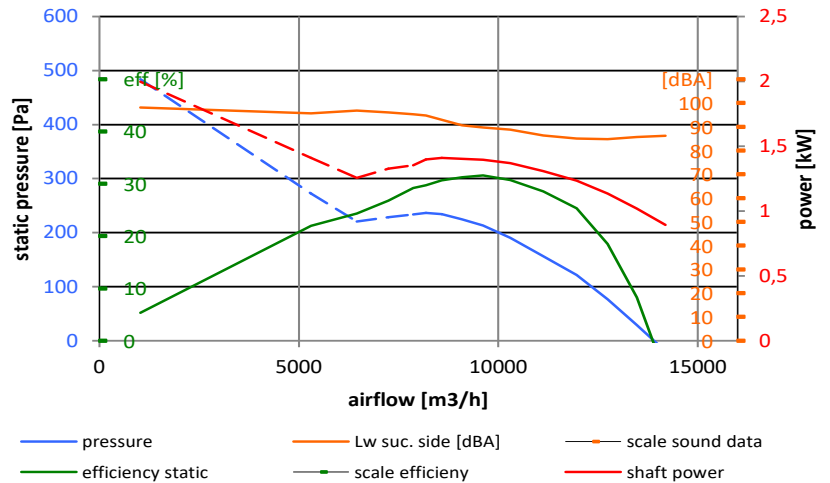

Measured in short casing with bellmouth without guard grille in installation type A according to ISO 5801.
Electrical data may change. Rated current could vary +/-10%.
The motor data in the operating point of the fan may vary.
Our motors meet or exceed the efficiency levels defined by the EISA of 2007 in the USA, NRC in Canada and IEC 60034-30 in Europe.

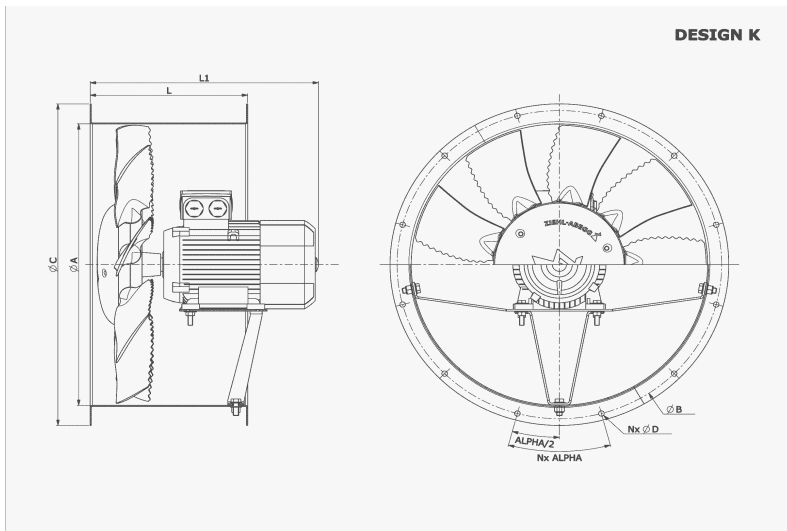

ØA	ØB	ØC	Ød	L	L1(*)	N	ALPHA
630	690	720	12	260	480	12	30

Fan estimated weight: 58,4 kg

Motor information - Rating plate data:

Brand:	CEMP
ATEX range:	Ex II 2G Ex de IIC T4
Size:	090L
Shaft power (P2):	1,5 kW
Supply:	D230/Y400 V 3~ 50Hz
Design:	IM B3, IM 1001
Current:	6,16/3,54 A
Eff. (100%):	77,3% (IE1)
Power factor:	0,79
Rated speed:	1402 /min (4 pole)
Deg. of protection:	IP65
Thermal class:	THCL 155
Temp.range:	-20/60 °C
Motor protection:	PTC
Pre-heater:	no
Tropicalisation:	no
Drain-holes:	no
Stainless st. plate:	no
Canopy cover:	no
Regreas.nipple:	no
Second nameplate:	no
Self-ventilation:	yes
Located bearings:	no
Material:	-
Certificate:	none
UL-CSA:	no

(*) indicative dimension that can change depending on the motor manufacturer. ZA standard motors here.
Drawing is showing standard configuration. Possible deviations are:
number of blades, position of terminal box, hub cover, blade orientation, (non exhaustive list).

Weight is given as an guideline. Small parts such as screws, cable, terminal box ... may have not been added to the total weight.
Calculated with CEMP motor here.