

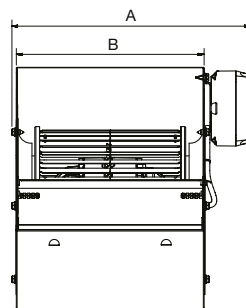

ErP conform

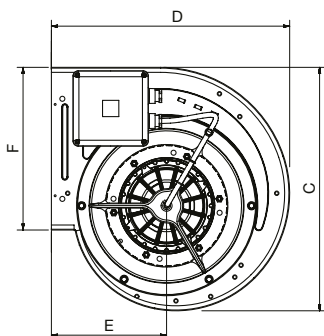

CBM 7-12

### Technické parametry

#### ■ Skříň

je z ocelového, galvanicky pozinkovaného plechu. Ventilátor je ve skříni přípevně pomocí odpružených profilů, aby se omezil přenos vibrací. Montážní konzoly pro upevnění ventilátoru ve 4 polohách jsou také z galvanicky pozinkovaného plechu (nejsou součástí dodávky).

#### ■ Oběžné kolo

je radiální, s dopředu zahnutými lopatkami. Oběžné kolo je z ocelového, galvanicky pozinkovaného plechu a je dynamicky vyváženo dle ISO 1940.

#### ■ Motor

je asynchronní s vnějším rotorem. Izolace je třídy F, vinutí je vybaveno termopojistkou proti přehřátí. Kuličková ložiska s tukovou náplní na dobu životnosti. Krytí IP44 (typy 7/7 a 7/9), IP55 (typy 9/7-12/12) nebo IP54 (typy 12/12 1100W a 15/15 2200W). Motory jednofázové 230 V/50 Hz nebo třífázové 230/400 V/50 Hz.

#### ■ Svorkovnice

je upevněna na skříni ventilátoru.

#### ■ Regulace otáček

jednofázových ventilátorů změnou napětí, u třífázových změnou napětí nebo frekvencí měničů.

#### ■ Montáž

ventilátoru v každé poloze osy ventilátoru, s ohledem na životnost ložisek přednostně horizontální montáž.

#### ■ Pokyny

Ventilátory jsou vhodné zejména pro konstrukci klimatizačních a větracích jednotek, dveřních a vratových clon, případně dalších vzduchotechnických aplikací. Informujte se na dodací podmínky a termíny dodávek.

Typ	A	B	C	D	E	F
CBM-7/7	296	233	328	309	145	207
CBM-7/9	363	300	328	309	145	207
CBM-9/7	316	233	390	381	184	260
CBM-9/9	382	300	390	381	184	260
CBM-10/8	340	267	443	423	200	288
CBM-10/10	407	333	443	423	200	288
CBM-12/9	382	311	521	490	229	341
CBM-12/12	466	396	521	490	229	341

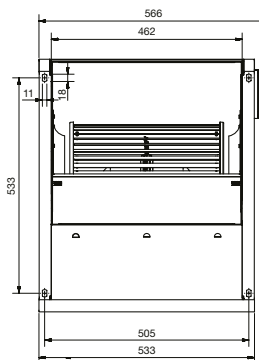
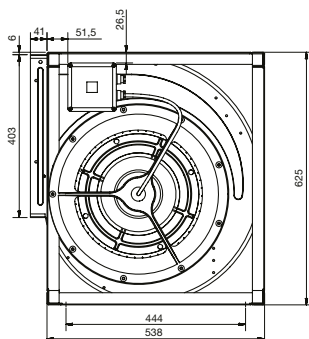

CBM 15

#### ■ Typový klíč pro objednávání

CBM 9 / 9 5 5 0 4 P T RE VR K  
1 2 3 4 5 6 7 8

- 1 – typ ventilátoru
- 2 – velikost oběžného kola v palcích: 7/7, 9/7, 9/9, 10/8, 10/10, 12/9, 12/12, 15/15
- 3 – příkon motoru [W]
- 4 – počet pólů
- 5 – nic: 1f motor  
T: 3f motor
- 6 – RE: motor s externím rotorem
- 7 – nic: jednonychlostní motor  
3V: třínychlostní motor  
VR: motor řízený napětím
- 8 – K: skříň s posílenou strukturou  
B: příruba na výtlačku

Typ	ekvivalentní rozměr [mm]	příkon [W]	napětí [V]	proud [A]	průtok [m³/h]	max teplota [°C]	akustický tlak* [dB(A)]	hmotnost [kg]	regulace
CBM-7/7 72W 6P RE VR	180/180	72	230	0,6	1440	70	56	6,5	REB 1; REV 1,5
CBM-7/7 147W 4P RE VR	180/180	147	230	1,2	1470	40	63	6,9	REB 2,5; REV 1,5
CBM-7/7 300W 4P RE VR	180/180	300	230	2,0	2200	60	64	7,2	REB 2,5; REV 3
CBM-7/9 72W 6P RE VR	180/240	72	230	0,9	1850	70	60	6,5	REB 1; REV 1,5
CBM-7/9 300W 4P RE VR	180/240	300	230	2,2	2530	40	67	9,8	REB 2,5; REV 3
CBM-9/7 200W 6P RE VR	240/180	200	230	1,5	1900	40	59	13,5	REB 2,5; REV 1,5
CBM-9/7 245W 6P RE VR	240/180	245	230	2,0	2650	50	64	14,0	REB 2,5; REV 3
CBM-9/7 420W 4P RE VR	240/180	420	230	3,2	2600	40	68	14,5	REB 5; REV 5
CBM-9/9 200W 6P RE VR	240/240	200	230	1,8	2760	40	63	14,0	REB 2,5; REV 3
CBM-9/9 245W 6P RE VR	240/240	245	230	2,2	2870	40	64	14,1	REB 2,5; REV 3
CBM-9/9 300W 4P RE VR	240/240	300	230	2,8	2500	40	64	16,7	REB 5; REV 5
CBM-9/9 550W 4P RE VR	240/240	550	230	4,3	3470	40	71	17,7	REB 5; REV 5
CBM-10/8 245W 6P RE VR	270/200	245	230	2,8	3490	40	67	14,9	REB 5; REV 5
CBM-10/8 515W 6P RE VR	270/200	515	230	3,3	3750	40	71	19,5	REB 5; REV 5
CBM-10/8 550W 4P RE VR	270/200	550	230	4,2	2900	40	68	18,6	REB 5; REV 5
CBM-10/10 245W 6P RE VR	270/270	245	230	2,8	3370	40	64	16,0	REB 5; REV 5
CBM-10/10 515W 6P RE VR	270/270	515	230	3,4	4090	40	67	17,5	REB 5; REV 5
CBM-10/10 600W 4P RE VR	270/270	600	230	4,6	3300	40	68	20,8	REB 10; REV 7
CBM-12/9 515W 6P RE VR	320/240	515	230	4,1	4195	40	65	21,5	REB 5; REV 5
CBM-12/9 750W 6P RE VR	320/240	750	230	5,5	4990	40	67	23,5	REB 10; REV 10
CBM-12/12 515W 6P RE VR	320/320	515	230	4,2	4540	40	66	22,0	REB 5; REV 5
CBM-12/12 750W 6P RE VR	320/320	750	230	5,3	5240	40	68	24,0	REB 10; REV 10
CBM-7/7 250W 4P T RE VR	180/180	250	230/400	1,2/0,7	2320	65	65	7,1	VFTM TRI 0,37
CBM-9/7 550W 4P T RE VR	240/180	550	230/400	3,1/1,8	3350	40	70	14,0	VFTM TRI 0,55
CBM-9/9 245W 6P T RE VR	240/240	245	230/400	1,6/0,9	3330	40	67	14,1	VFTM TRI 0,37
CBM-9/9 550W 4P T RE VR	240/240	550	230/400	5,5/3,2	4830	40	75	14,1	VFTM TRI 1,1
CBM-10/8 245W 6P T RE VR	270/200	245	230/400	1,9/1,1	3470	40	68	14,9	VFTM TRI 0,37
CBM-10/8 350W 6P T RE VR	270/200	350	230/400	2,8/1,6	4330	40	73	14,9	VFTM TRI 0,55
CBM-10/8 550W 4P T RE VR	270/200	550	230/400	5,4/3,1	4280	40	72	18,9	VFTM TRI 1,1
CBM-10/10 245W 6P T RE VR	270/270	245	230/400	1,9/1,1	3920	40	67	16,0	VFTM TRI 0,37
CBM-10/10 350W 6P T RE VR	270/270	350	230/400	2,9/1,7	5000	40	72	20,0	VFTM TRI 0,55
CBM-10/10 550W 4P T RE VR	270/270	550	230/400	5,0/2,9	4010	40	70	20,0	VFTM TRI 1,1
CBM-10/10 750W 4P T RE VR	270/270	750	230/400	7,6/4,4	5880	40	76	20,0	VFTM TRI 1,5
CBM-12/12 550W 6P T RE VR	320/320	550	230/400	5,0/2,9	6490	40	73	22,0	VFTM TRI 1,1
CBM-12/12 750W 6P T RE VR	320/320	750	230/400	5,9/3,4	7480	40	75	22,0	VFTM TRI 1,5
CBM-12/12 1100W 6P T RE VR	320/320	1100	230/400	5,7/3,3	7410	40	75	25,0	VFTM TRI 1,5
CBM-15/15 2200W 6P T RE VR K	380/380	2200	230/400	12/2/7	11650	40	75	43,0	VFTM TRI 3

\* akustický tlak měřený ve volném akustickém poli ve vzdálenosti 1,5 m na straně sání

## Doplnující vyobrazení



LG 0



LG 90



speciální antivibrační upevnění motoru

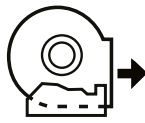

LG 270



LG 180



dynamicky vyvážené oběžné kolo

4 polohy montáže pomocí mont. konzoly

## Příslušenství



VFN frekvenční měnič (K 8.1)

 návrh frekvenčního měniče  
tel.: 602 679 469

## Charakteristiky

### Vysvětlivky - tabulka:

- MC kategorie měření
- EC kategorie energetické účinnosti
- VSD regulace otáček: dodávána s ventilátorem
- SR specifický poměr
- $\eta$  [%] celková účinnost
- N účinnost
- [kW] výkon na hřídeli
- [m<sup>3</sup>/h] průtok vzduchu
- [Pa] statický tlak
- [RPM] otáčky za minutu

### Vysvětlivky - graf:

- P<sub>st</sub> statický tlak v Pa
- Q objem vzduchu v m<sup>3</sup>/h
- SFP měrný výkon ventilátoru v W/m<sup>3</sup>/s
- I proud v A
- L<sub>w</sub> akustický výkon na sání v dB(A)

Kategorie měření: B, kategorie energetické účinnosti celková. Účinnost ventilátoru bez regulace otáček. Ventilátor testovaný bez ochranného krytu. Údaje o proudění vzduchu podle ISO 5801.

CBM-7/7 72 6P RE VR

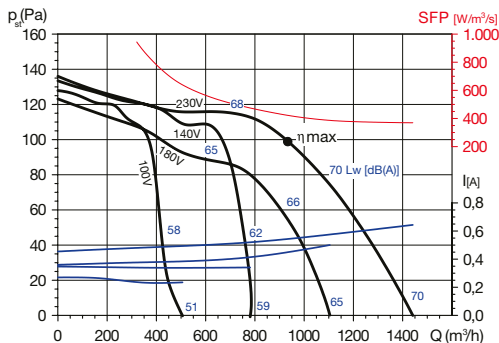

MC	EC	VSD	SR	$\eta$ [%]	N	[kW]	[m <sup>3</sup> /h]	[Pa]	[RPM]
B	Total	Ne	1	27,7	40,1	0,110	933	117	883

CBM-7/7 147 4P RE VR

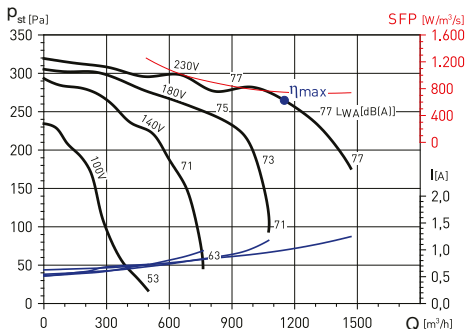

MC	EC	VSD	SR	$\eta$ [%]	N	[kW]	[m <sup>3</sup> /h]	[Pa]	[RPM]
B	Total	Ne	1	39,0	49,3	0,239	1150	292	1346

CBM-7/7 300 4P RE VR

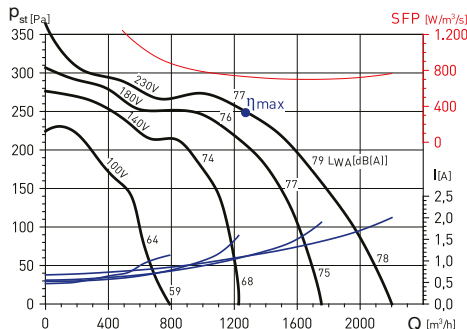

MC	EC	VSD	SR	$\eta$ [%]	N	[kW]	[m <sup>3</sup> /h]	[Pa]	[RPM]
B	Total	Ne	1	39,1	49,1	0,258	1270	286	1370

CBM-7/9 72 6P RE VR

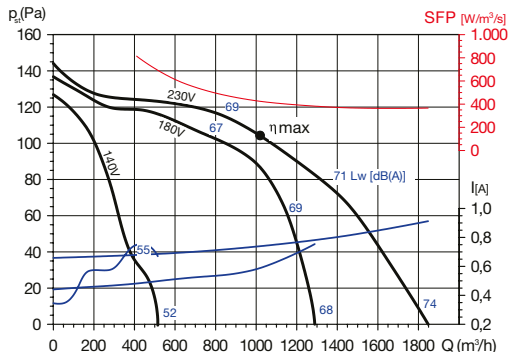

MC	EC	VSD	SR	$\eta$ [%]	N	[kW]	[m <sup>3</sup> /h]	[Pa]	[RPM]
B	Total	Ne	1	27,4	39,5	0,120	1020	116	920

CBM-7/9 300 4P RE VR

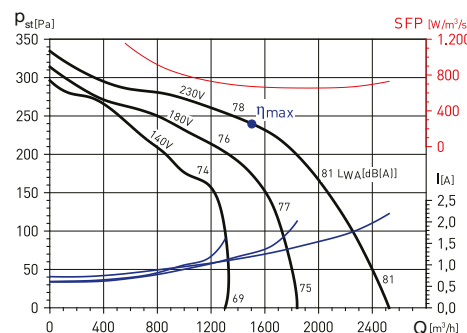

MC	EC	VSD	SR	$\eta$ [%]	N	[kW]	[m <sup>3</sup> /h]	[Pa]	[RPM]
B	Total	Ne	1	39,5	49,3	0,283	1508	266	1343

Charakteristiky

**CBM-9/7 200 6P RE VR**

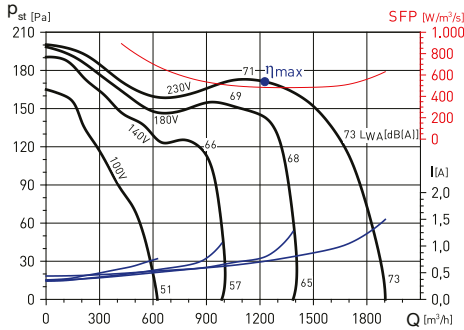

MC	EC	VSD	SR	$\eta$ [%]	N	[kW]	[m <sup>3</sup> /h]	[Pa]	[RPM]
B	Total	Ne	1	39,5	50,8	0,165	1227	191	914

**CBM-9/7 245 6P RE VR**

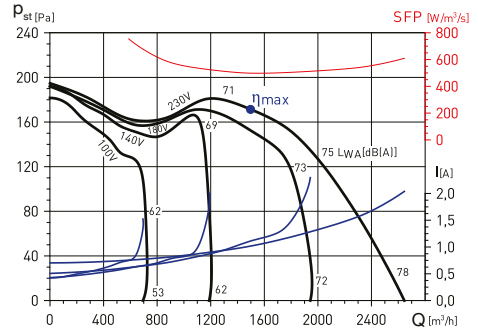

MC	EC	VSD	SR	$\eta$ [%]	N	[kW]	[m <sup>3</sup> /h]	[Pa]	[RPM]
B	Total	Ne	1	40,0	50,6	0,207	1495	200	951

**CBM-9/7 420 4P RE VR**

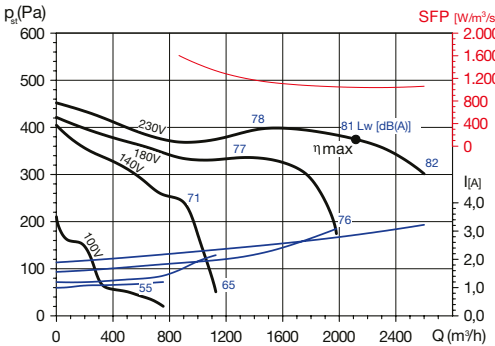

MC	EC	VSD	SR	$\eta$ [%]	N	[kW]	[m <sup>3</sup> /h]	[Pa]	[RPM]
B	Total	Ne	1	41,3	49	0,612	2118	429	1377

**CBM-9/9 200 6P RE VR**

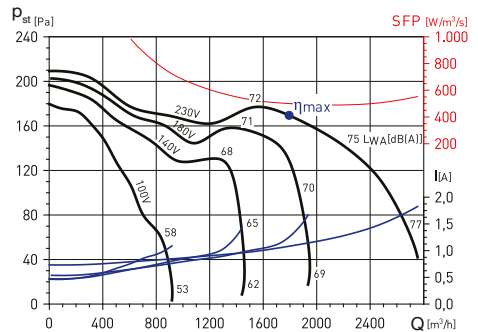

MC	EC	VSD	SR	$\eta$ [%]	N	[kW]	[m <sup>3</sup> /h]	[Pa]	[RPM]
B	Total	Ne	1	38,9	49,0	0,249	1792	195	915

**CBM-9/9 245 6P RE VR**

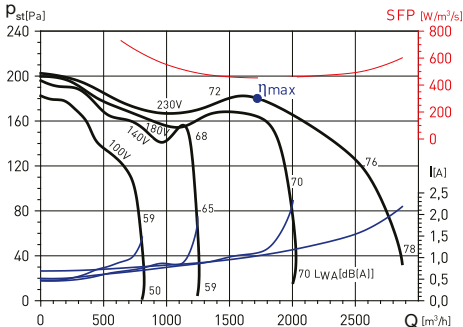

MC	EC	VSD	SR	$\eta$ [%]	N	[kW]	[m <sup>3</sup> /h]	[Pa]	[RPM]
B	Total	Ne	1	44,5	55,0	0,215	1714	201	947

**CBM-9/9 300 4P RE VR**

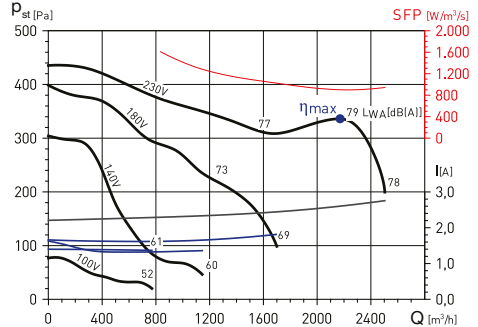

MC	EC	VSD	SR	$\eta$ [%]	N	[kW]	[m <sup>3</sup> /h]	[Pa]	[RPM]
B	Total	Ne	1	41,1	49,	0,545	2177	374	1277

Charakteristiky

**CBM-9/9 550 4P RE VR**

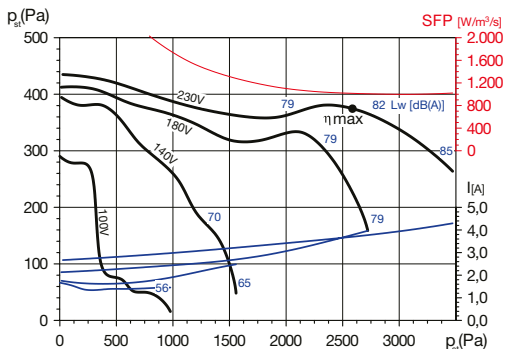

MC	EC	VSD	SR	$\eta$ [%]	N	[kW]	[ $m^3/h$ ]	[Pa]	[RPM]
B	Total	Ne	1	41,8	49	0,730	2588	424	1387

**CBM-10/8 245 6P RE VR**

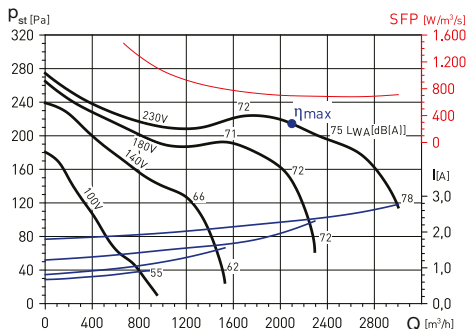

MC	EC	VSD	SR	$\eta$ [%]	N	[kW]	[ $m^3/h$ ]	[Pa]	[RPM]
B	Total	Ne	1	45,5	54,3	0,405	2336	284	949

**CBM-10/8 515 6P RE VR**

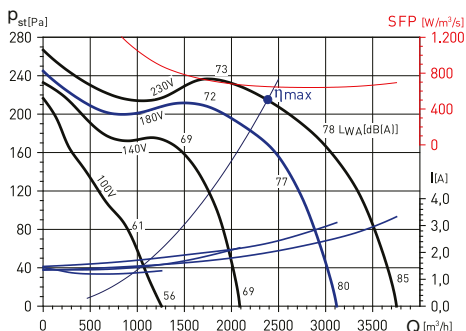

MC	EC	VSD	SR	$\eta$ [%]	N	[kW]	[ $m^3/h$ ]	[Pa]	[RPM]
B	Total	Ne	1	40,4	49,0	0,430	2382	262	917

**CBM-10/8 550 4P RE VR**

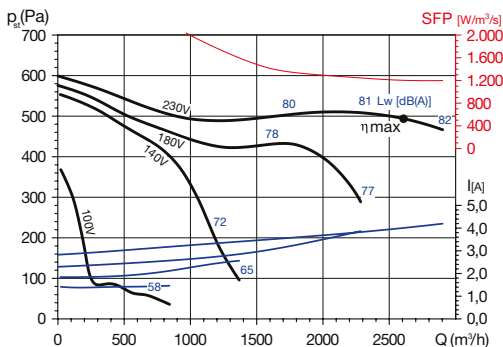

MC	EC	VSD	SR	$\eta$ [%]	N	[kW]	[ $m^3/h$ ]	[Pa]	[RPM]
B	Total	Ne	1	45,1	51,8	0,872	2610	542	1353

**CBM-10/10 245 6P RE VR**

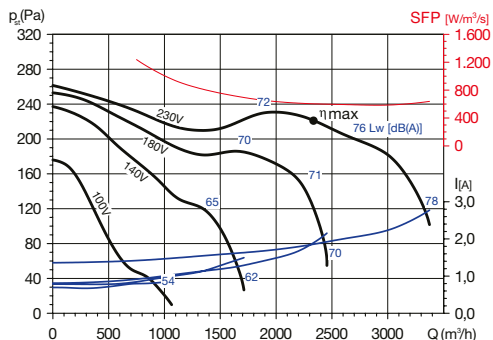

MC	EC	VSD	SR	$\eta$ [%]	N	[kW]	[ $m^3/h$ ]	[Pa]	[RPM]
B	Total	Ne	1	41	49,9	0,391	2334	248	905

**CBM-10/10 515 6P RE VR**

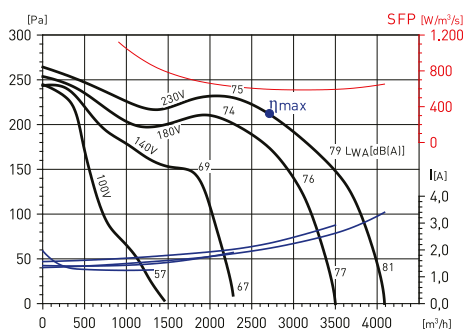

MC	EC	VSD	SR	$\eta$ [%]	N	[kW]	[ $m^3/h$ ]	[Pa]	[RPM]
B	Total	Ne	1	42,6	51,2	0,440	2654	254	914

Charakteristiky

**CBM-10/10 600 4P RE VR**

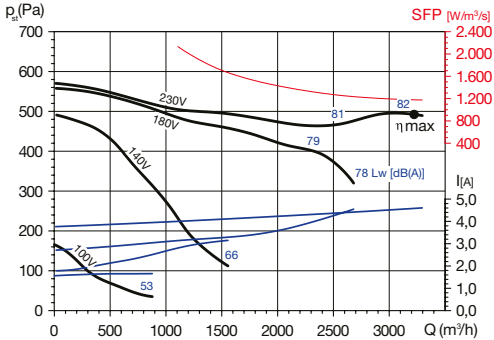

MC	EC	VSD	SR	$\eta$ [%]	N	[kW]	[m³/h]	[Pa]	[RPM]
B	Total	Ne	1	45,9	52,1	1,056	3226	542	1387

**CBM-12/9 515 6P RE VR**

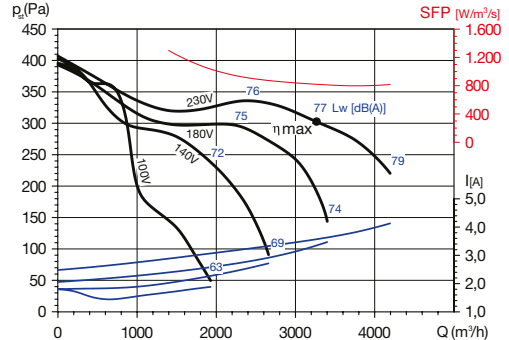

MC	EC	VSD	SR	$\eta$ [%]	N	[kW]	[m³/h]	[Pa]	[RPM]
B	Total	Ne	1	42,6	49,7	0,744	3267	349	885

**CBM-12/9 750 6P RE VR**

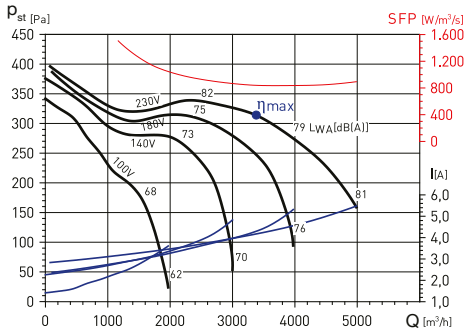

MC	EC	VSD	SR	$\eta$ [%]	N	[kW]	[m³/h]	[Pa]	[RPM]
B	Total	Ne	1	42,9	49,9	0,788	3380	360	913

**CBM-12/12 515 6P RE VR**

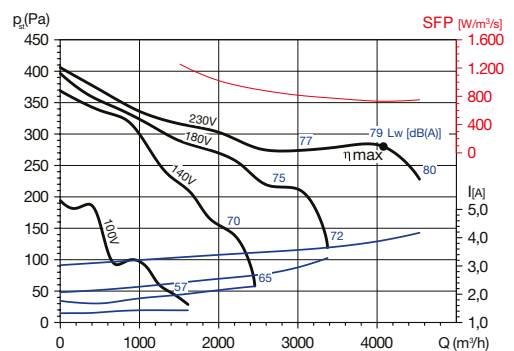

MC	EC	VSD	SR	$\eta$ [%]	N	[kW]	[m³/h]	[Pa]	[RPM]
B	Total	Ne	1	43,8	50,7	0,826	4084	323	865

**CBM-12/12 750 6P RE VR**

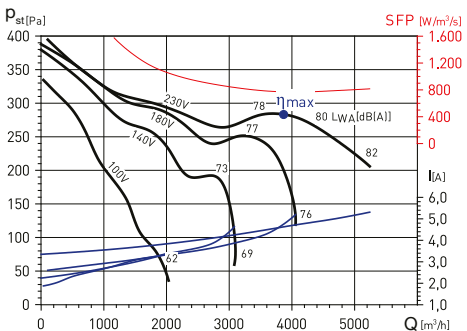

MC	EC	VSD	SR	$\eta$ [%]	N	[kW]	[m³/h]	[Pa]	[RPM]
B	Total	Ne	1	42,3	49,1	0,832	3900	325	899

**CBM-7/7 250 4PT RE VR**

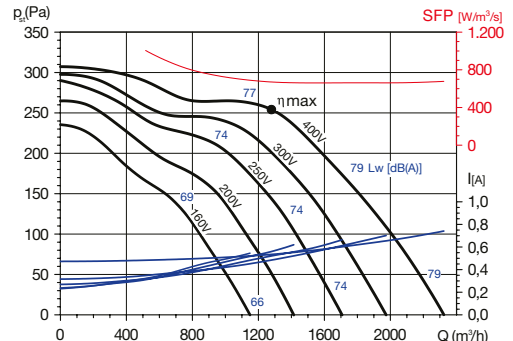

MC	EC	VSD	SR	$\eta$ [%]	N	[kW]	[m³/h]	[Pa]	[RPM]
B	Total	Ne	1	45,2	55,5	0,238	1280	303	1359

Charakteristiky

**CBM-9/7 550 4PT RE VR**

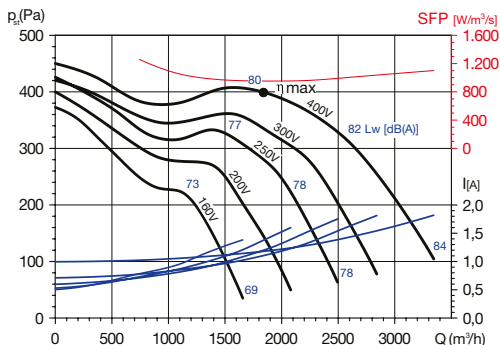

MC	EC	VSD	SR	$\eta$ [%]	N	[kW]	[ $m^3/h$ ]	[Pa]	[RPM]
B	Total	Ne	1	46,7	55,0	0,487	1839	445	1396

**CBM-9/9 245 6PT RE VR**

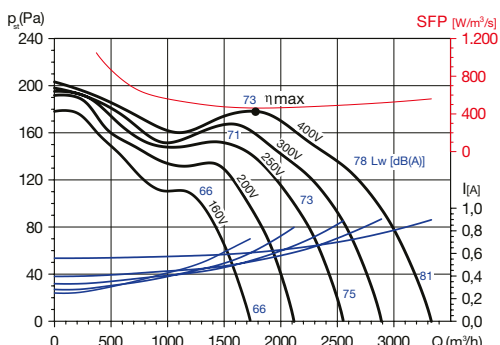

MC	EC	VSD	SR	$\eta$ [%]	N	[kW]	[ $m^3/h$ ]	[Pa]	[RPM]
B	Total	Ne	1	43,9	54,3	0,230	1787	208	947

**CBM-9/9 550 4PT RE VR**

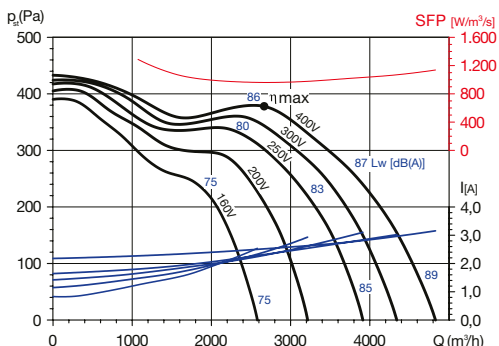

MC	EC	VSD	SR	$\eta$ [%]	N	[kW]	[ $m^3/h$ ]	[Pa]	[RPM]
B	Total	Ne	1	44,9	52,2	0,711	2663	433	1430

**CBM-10/8 245 6PT RE VR**

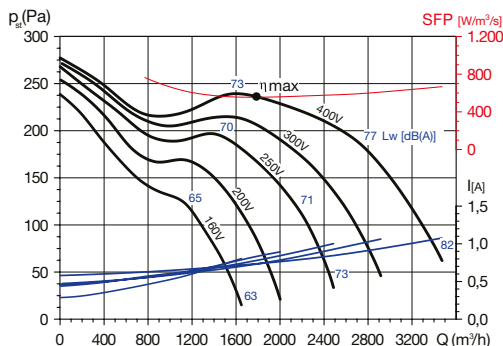

MC	EC	VSD	SR	$\eta$ [%]	N	[kW]	[ $m^3/h$ ]	[Pa]	[RPM]
B	Total	Ne	1	46,6	56,5	0,273	1774	258	931

**CBM-10/8 350 6PT RE VR**

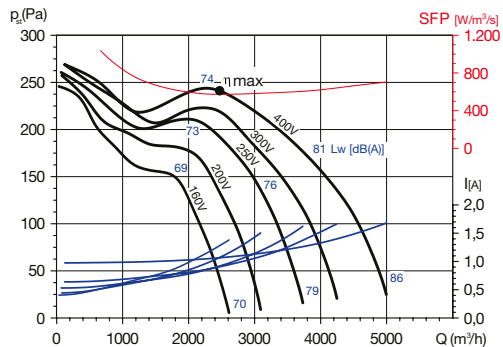

MC	EC	VSD	SR	$\eta$ [%]	N	[kW]	[ $m^3/h$ ]	[Pa]	[RPM]
B	Total	Ne	1	44,3	53,3	0,377	2147	280	954

**CBM-10/8 550 4PT RE VR**

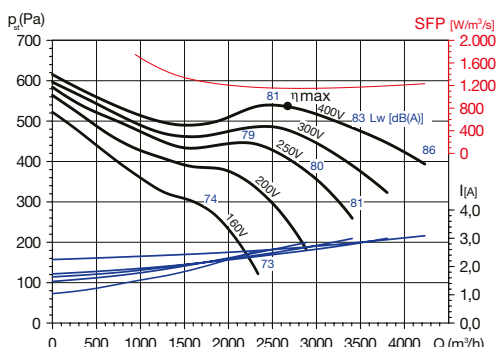

MC	EC	VSD	SR	$\eta$ [%]	N	[kW]	[ $m^3/h$ ]	[Pa]	[RPM]
B	Total	Ne	1	50,5	57,3	0,853	2668	581	1409

Charakteristiky

**CBM-10/10 245 6PT RE VR**

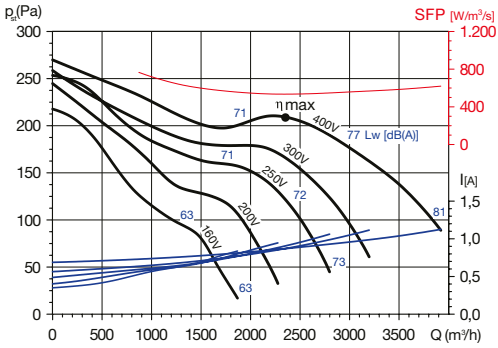

MC	EC	VSD	SR	$\eta$ [%]	N	[kW]	[m³/h]	[Pa]	[RPM]
B	Total	Ne	1	43,8	53	0,35	2357	234	906

**CBM-10/10 350 6PT RE VR**

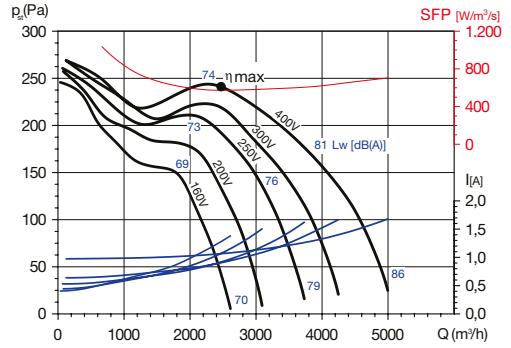

MC	EC	VSD	SR	$\eta$ [%]	N	[kW]	[m³/h]	[Pa]	[RPM]
B	Total	Ne	1	46,9	55,8	0,393	2465	269	949

**CBM-10/10 550 4PT RE VR**

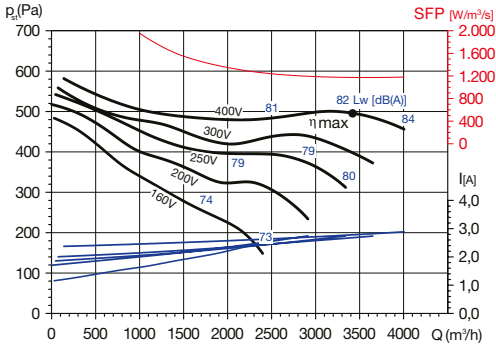

MC	EC	VSD	SR	$\eta$ [%]	N	[kW]	[m³/h]	[Pa]	[RPM]
B	Total	Ne	1	46,9	52,9	1,116	3422	550	1373

**CBM-10/10 750 4PT RE VR**

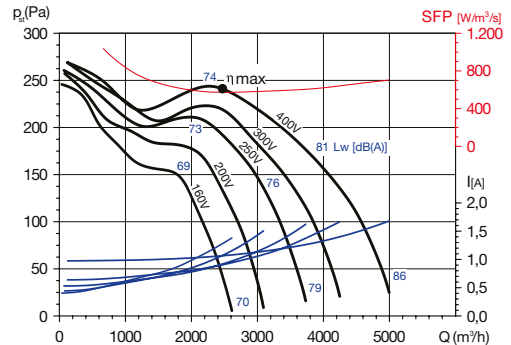

MC	EC	VSD	SR	$\eta$ [%]	N	[kW]	[m³/h]	[Pa]	[RPM]
B	Total	Ne	1	47,8	53,7	1150	3379	586	1431

**CBM-12/12 550 6PT RE VR**

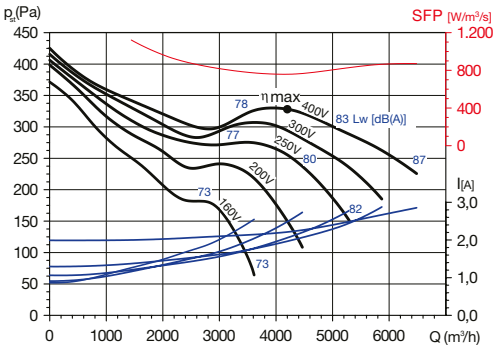

MC	EC	VSD	SR	$\eta$ [%]	N	[kW]	[m³/h]	[Pa]	[RPM]
B	Total	Ne	1	50,7	57,4	0,886	4202	387	939

**CBM-12/12 750 6PT RE VR**

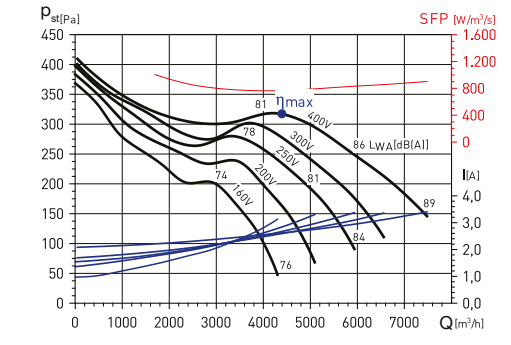

MC	EC	VSD	SR	$\eta$ [%]	N	[kW]	[m³/h]	[Pa]	[RPM]
B	Total	Ne	1	47,9	54,4	0,937	4397	368	936

111



**CBM-12/12 1100 6PT RE VR**

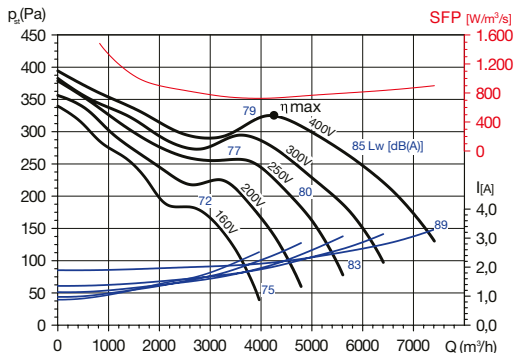

MC	EC	VSD	SR	$\eta$ [%]	N	[kW]	[m <sup>3</sup> /h]	[Pa]	[RPM]
B	Total	Ne	1	51,0	57,7	0,862	4247	373	925

**CBM-15/15 2200 6PT RE VR**

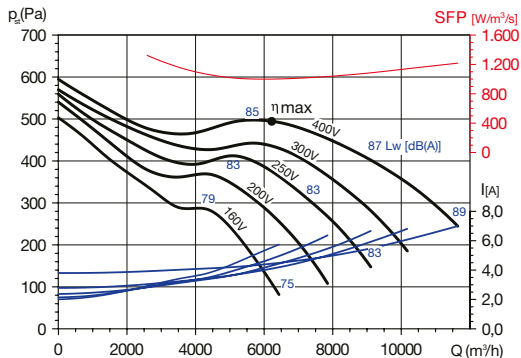

MC	EC	VSD	SR	$\eta$ [%]	N	[kW]	[m <sup>3</sup> /h]	[Pa]	[RPM]
B	Total	Ne	1	54,7	59,5	1,725	6209	547	934

## Příslušenství

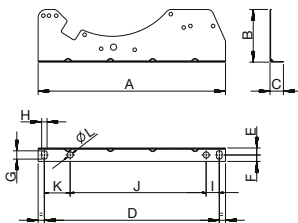
**■ CBP/CBM – montážní konzoly**

- vyrobená z galvanizovaného pozinkovaného plechu
- umožňuje 4 základní polohy montáže ventilátoru, navzájem otočené o 90°  
- LG 0, LG 90, LG 180, LG 270

Typ	A	B	C	D	E	F	G	H	I	J	K	L
7/	254	47	26	227	13,5	12,5	16	10,5	15	195	15	12
9/	325	102	26	297	13,5	12,5	16	10,5	–	–	35,7	10,5
10/	363	102	26	339	13,5	12,5	16	10,5	37,5	263,5	62	12
12/	434	144	26	407	13,5	12,5	16	10,5	48	333,5	25,5	12

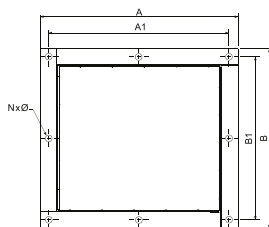
**■ BRIDA CBM**

- příruba na výtlačku ventilátoru

Typ	A	A1	B	B1	N x Ø (mm)
BRIDA CBM-7/7	289	264	265	240	8 x 9
BRIDA CBM-9/7	273	253	302	280	8 x 9
BRIDA CBM-9/9	360	328	315	285	8 x 10
BRIDA CBM-10/8	314	293	339	316	8 x 9
BRIDA CBM-10/10	380,5	359	339	316	8 x 9
BRIDA CBM-12/9	362	341	394,5	374	8 x 9
BRIDA CBM-12/12	447	426	394,5	374	8 x 9