

Serie **PCM** Series

Serie di ventilatori a pale radiali.

Versioni:

Standard: coclea stampata Pe - girante PP - supporto motore in lamiera di acciaio verniciato polveri - viteria acciaio INOX

ATEX: coclea stampata Pe-el conduttivo - girante PP - supporto motore in lamiera di acciaio verniciato polveri - viteria acciaio INOX

Fans series with radial blades

Versions:

Standard: Pe moulded housing - PP impeller - epoxy painted motor support - stainless steel screws

ATEX: Pe-el antistatic housing - PP impeller - epoxy painted motor support - stainless steel screws

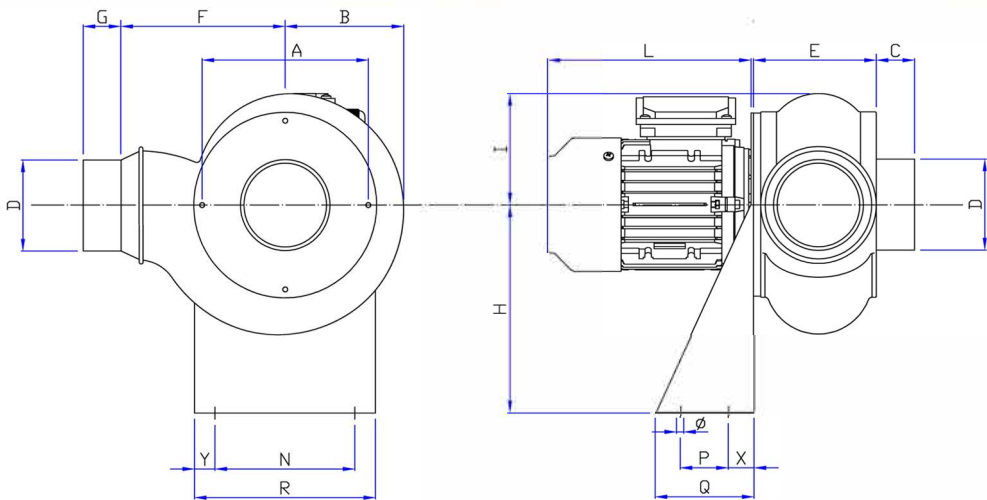
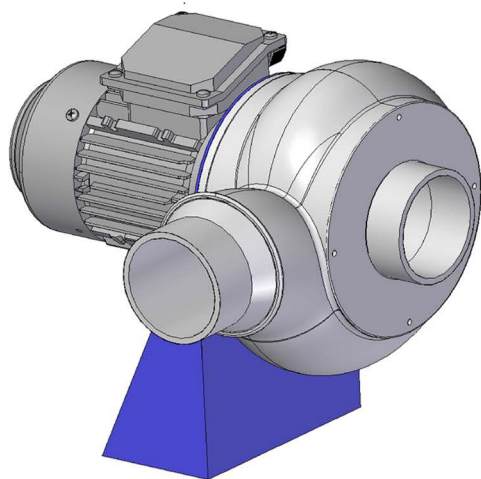

Tipo Type	Mot.Gr. Size	Mot. Kw	Giri Rpm	A	B	C	D	E	F	G	H	I	L	N	P	Q	R	Y	X	Ø	KG.*	KG.**
PCM 125/75	56	0.09	1400	139	100	30	75	105	122	30	172	98	170	117	40	82	155	19	22	10	5	6
	56	0.12	2800	139	100	30	75	105	122	30	172	98	170	117	40	82	155	19	22	10	5	6
PCM 150/90	56	0.09	1400	170	120	30	90	126	190	30	190	112	170	151	40	82	189	19	22	10	6	7
	56	0.12	2800	170	120	30	90	126	190	30	190	112	170	151	40	82	189	19	22	10	6	7
PCM 150/110	56	0.09	1400	170	120	30	110	126	150	30	190	112	170	151	40	82	189	19	22	10	6.5	8
	56	0.12	2800	170	120	30	110	126	150	30	190	112	170	151	40	82	189	19	22	10	6.5	8

* esecuzione con motore standard – standard motor execution

** esecuzione ATEX – ATEX execution

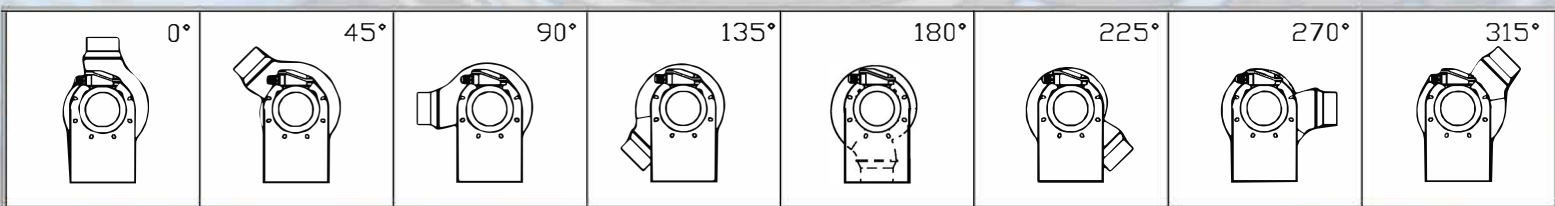

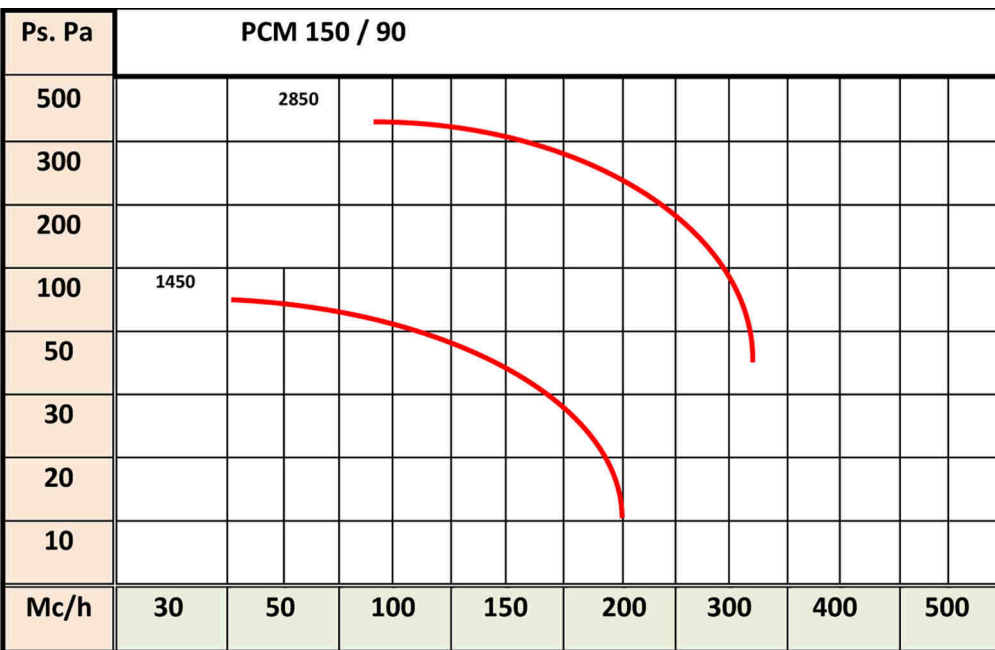

PCM 150 / 90		
Giri/Rpm	1450	2850
Kw inst.	0.09	0.12
Amp.volt 400/3	0.3	0.38
Amp.volt 230/1	1.1	1.2
dbA	47	58